

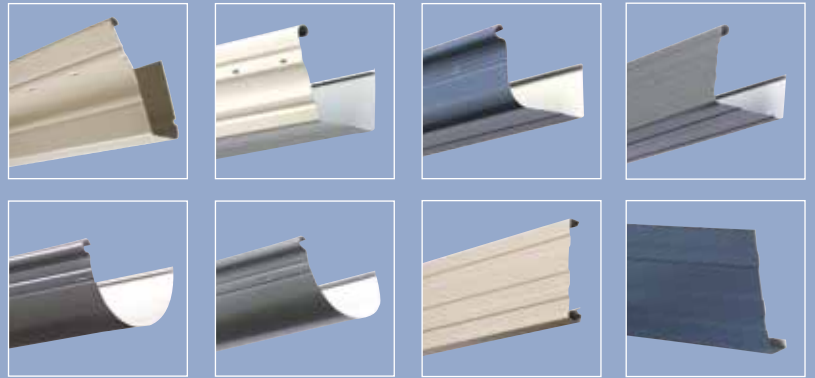

PRODUCT BROCHURE



QUALITY GUTTERING
SINCE 1953

CONTENTS

3	CEO MESSAGE
4	DURAKOTE®
6	ACE QUAD GUTTER
7	STEEL FASCIA
7	BARGE SOAKER
8	FASCIA COVER
8	VALLEY
9	HALF ROUND GUTTER
10	ROUNDLINE GUTTER
11	NU-LINE GUTTER
12	MINI-LINE GUTTER
13	SQUARE-LINE GUTTER
13	OLD STYLE QUAD GUTTER
14	100 X 50MM & 100 X 75MM ROLLFORM DOWNPIPE
15	90MM ROUND DOWNPIPE
15	RAINWATER HEADS & LEAFGUARDS
16	ACCESSORIES & COMPATABILITY
17	DIMENSIONS
18	PREMIUM PRODUCTS
21	ACE COLOUR RANGE
22	ACE PLUMBING SUPPLIES

CEO MESSAGE

MR DON ANDERSON CEO OF ACE GUTTERS PTY LTD

For over 60 years Ace Gutters has maintained a reputation as a manufacturer of the highest quality rainwater products.

Established in 1953 our philosophy has been to adapt and evolve within a changing marketplace, through product innovation and design, manufacturing techniques and technological advancements.

To this end Ace Gutters recently undertook the significant capital investment of purchasing a state of the art Bronx International Continuous Coil Coating Line.

This Continuous Coil Coating Line located at our head office at Mortdale NSW has allowed Ace Gutters to design and introduce to the marketplace a new pre painted steel product called **DURAKOTE®** a product that we believe will set a new industry benchmark and that has been specifically designed for the rainwater products industry.

DURAKOTE® is supported by a Rainwater Products Warranty of 20 years.

Ace Gutters are also proud to announce that **DURAKOTE®** has been endorsed and licensed by the Australian Made Campaign as being AUSTRALIAN MADE & OWNED.

Ace Gutters can now ensure a quality process from the painting of our steel, to the slitting of coil, rollforming of our rainwater products, powder coating of our fittings, storage and transportation of our finished product.

In summary Ace Gutters now offer the market a new and improved pre painted steel product which is fully supported with the relevant technical data, product specification sheets and individual product warranties

Ace Gutters remain at the forefront of the rainwater products industry and will continue to look at new and innovative ways of meeting and exceeding market expectations.

Don Anderson
CEO

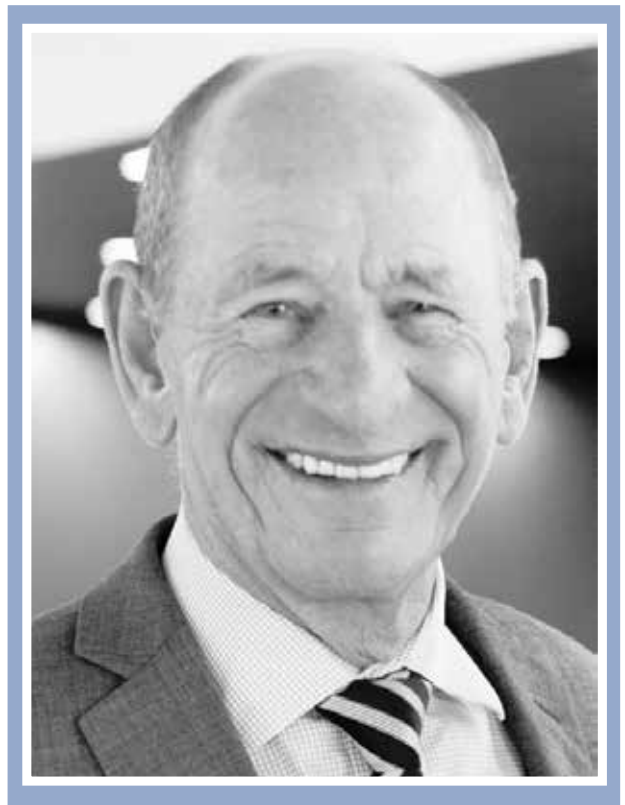

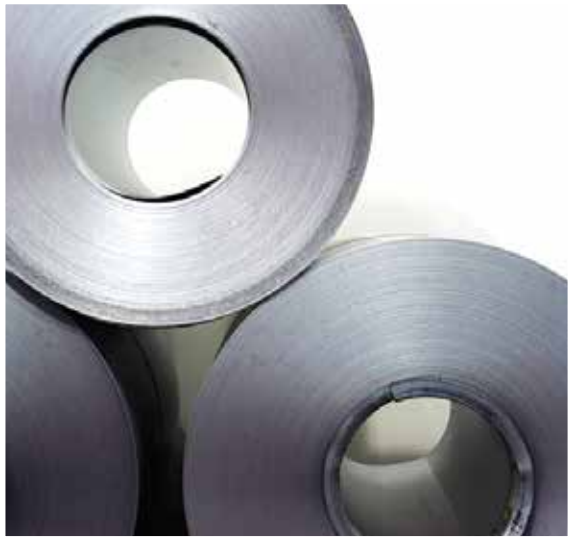

DURAKOTE® is a painted steel product that has been designed specifically for the rainwater products industry.

DURAKOTE® is a highly durable painted steel product offering superior corrosion resistance, allowing it to withstand Australia's harsh weather conditions.

For this reason DURAKOTE® is supported by a 20 year Rainwater Products Warranty, covering gutter, fascia and downpipe.

DURAKOTE® SUBSTRATE

- 1 Backing Coat (Nominal 6 µm)
- 2 Corrosion Resistant Primer
- 3 Corrosion Resistant coating
- 4 AluZinc (Aluminium Zinc Alloy Coated Steel) AZ165
- 5 Corrosion Resistant Coating
- 6 Corrosion Resistant Primer (Nominal 5µm)
- 7 Finish Coat (Nominal 20µm)

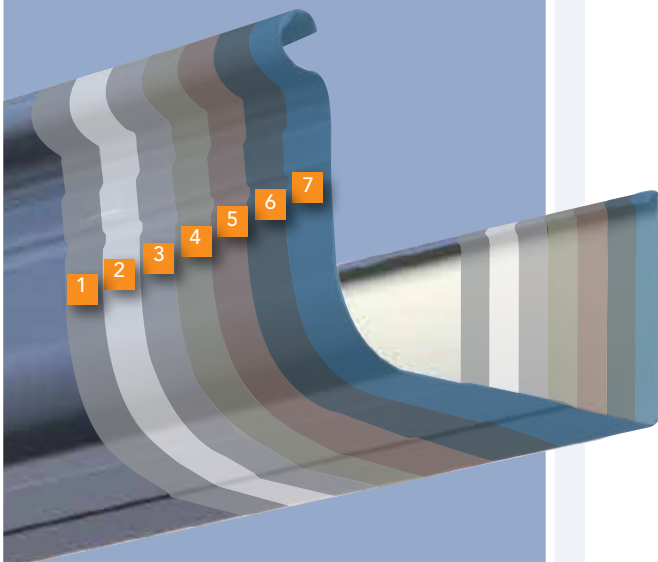

THE SUBSTRATE

DURAKOTE® is manufactured from the world's most recognised steel substrate Aluzinc (Al-Zn 55%), a substrate that complies with the Standard ASTM A792M.

Aluzinc is a substrate that was developed in America during the 1960's by a company called Bethlehem Steel.

Their research focused on the range of aluminium/zinc binary alloys and its effects on corrosion resistance when applied to steel.

Both laboratory and long term outdoor exposure tests showed that the alloy which gives optimum corrosion resistance is 55% aluminium, 43.4% zinc and 1.6% silicon.

THE PAINT FINISH

DURAKOTE® also offers a superior paint finish, using a high quality polyester paint with an oven baked finish that resists peeling and flaking.

This allows Ace to guarantee to its customers a product that not only offers a modern and fresh look to a home, but also a product that will last for many years to come.

Utilising state of the art paint technology DURAKOTE® paint finish has been designed to meet Australian Standard AS2728.



ACE GUTTERS IS PROUD TO INTRODUCE TO THE AUSTRALIAN RAINWATER PRODUCTS INDUSTRY **DURAKOTE®**.

OUR COLOUR CHOICE

DURAKOTE® is available in a wide variety of colours, and will match any steel roofing colour available in the marketplace today.

Due to **DURAKOTE®** advanced coating system and superior grade substrate (AZ165) Ace Products are compatible with any painted steel roof.

PROVEN EXPERIENCE

With over 60 years experience in the rainwater products industry, specialising in the manufacturing of gutters, fascia, downpipes, accessories and with continual improvement in manufacturing techniques, product innovation, research and development you can be confident **DURAKOTE®** is a product that "we believe will set a new industry benchmark."

AUSTRALIAN MADE & OWNED

Established since 1953 Ace Gutters is a wholly owned Australian company.

From our manufacturing plants in NSW & Victoria, we control the entire production process. This includes painting, slitting, rollforming, die casting, powder coating, storing and transporting our products.

For these reasons we have gained the recognition and support of the Australian Made Campaign and are proud to exhibit and promote the Australian Made & Owned logo on gutter, downpipe, fascia, fascia cover, barge soaker and valley produced by **DURAKOTE®**.

You the customer can be proud to have purchased a product from an Australian owned business that has for many years utilised the skills and experience of the local community.



Choose Ace products made from **DURAKOTE®** and you will know that you are making a wise investment, purchasing a high quality Australian made product backed with an Ace Gutters 20 year warranty.

INCOMPATIBLE METALS

To avoid any corrosion please avoid using incompatible metals Copper and Lead with **DURAKOTE®**.

Copper pipes and lead flashings should not come in direct contact with **DURAKOTE®** or Aluzinc at any time.

Fixings made of Stainless Steel and fixings containing copper should also not be used with **DURAKOTE®** or Aluzinc.

PROTECTIVE PLASTIC FILM

DURAKOTE® is protected with a protective polyethelene strippable film to ensure your product is protected during the manufacturing & distribution process. The film is easily removable & manufactured from recyclable material.

This protective film must be removed prior to installation and to ensure that the protective film is easily removed please endeavour to ensure that the product is not left in direct sunlight or heat during the warmer months.

INSTALLATION CLEANING

Please ensure after installation, that all deposits of swarf and metal particles from self drilling screws, rivets, nails be swept away and washed from the gutter, roof at the end of each day. If you fail to do so it will void the warranty.

No responsibility will be taken if **DURAKOTE®** comes into contact with Acid when cleaning brickwork. Please advise acid wash contractors to wash off and rinse with clean water all gutter, fascia & downpipes. Product warranties are void if corrosion occurs as a result of contamination.



ACE QUAD

FLOW RATE:

Volume in 1m length 1.5 litres / second.
6.2 litres measured to overflow holes.

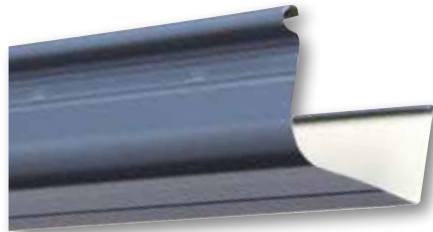

NSW • ACT • VICTORIA

ACE QUAD 115MM DURAKOTE® 80% GLOSS

Available Slotted or Unslotted.

Hunter Red, White, Federation Green, Brown, Heritage Red, Smooth Cream, Merino, Jasmin Brown, Slate Grey, Iron Grey.

ACE QUAD DURAKOTE® 25% GLOSS

Available Slotted or Unslotted.

Heritage Red, Smooth Cream, Merino, Jasmin Brown, Slate Grey, Iron Grey, Mountain Blue, Dusk, Off White, Birch, Gull Grey, Armour Grey, Mist Green, Rivergum, Caulfield Green, Monolith, Ebony, Territory, Coventry, Gulf, Manteal, Basal, Wallaroo.

ACE QUAD 115MM PLAIN

Available Slotted & Unslotted

		
EXTERNAL 90° ANGLE	INTERNAL 90° ANGLE	EXTERNAL 45° ANGLE
		
INTERNAL 45° ANGLE	EXTERNAL BRACKET	
		
RIGHT & LEFT HAND RETURN STOP END	STOP END	CONCEALED SUSPENSION BRACKET
		
OVERSTRAP BRACKET	CONCEALED BRACKET	TIMBER SUSPENSION CLIP
		
QUAD OVERFLOW NOZZLE	METAL FASCIA SUSPENSION CLIP	10MM AND 5MM ACE SPACER CLIP
		
LEAFGUARD		
N.B Leafguard requires some degree of maintenance after installation.		

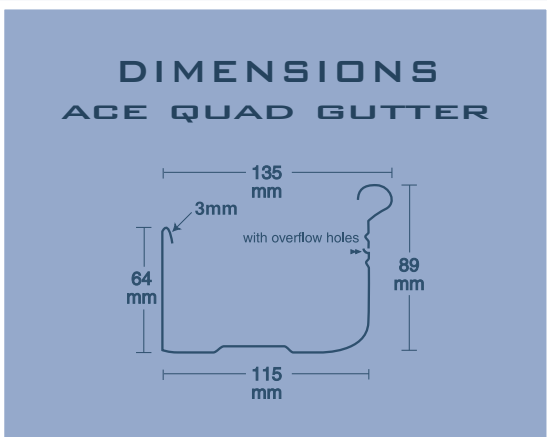



STEEL FASCIA



NSW • ACT • VICTORIA

STEEL FASCIA DURAKOTE® 25% GLOSS

White, Heritage Red, Smooth Cream, Merino, Jasmin Brown, Slate Grey, Iron Grey, Mountain Blue, Dusk, Off White, Birch, Gull Grey, Armour Grey, Mist Green, Caulfield Green, Monolith, Ebony, Basal, Territory, Wallaroo, Gulf, Manteal, Coventry.

STEEL FASCIA PLAIN - Custom Cut Only

BARGE SOAKER DURAKOTE® 80% GLOSS

Hunter Red, White, Federation Green, Brown, Heritage Red, Smooth Cream, Merino, Jasmin Brown, Slate Grey, Iron Grey.

BARGE SOAKER DURAKOTE® 25% GLOSS

Dusk, Off White, Birch, Gull Grey, Armour Grey, Mist Green, Rivergum, Caulfield Green, Monolith, Ebony, Basal, Territory, Wallaroo, Gulf, Manteal, Coventry.

BARGE SOAKER PLAIN



DIMENSIONS STEEL FASCIA

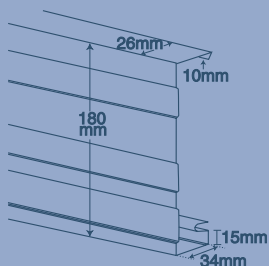

BARGE SOAKER

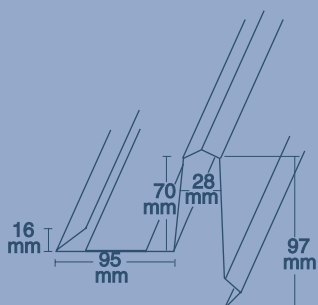

BARGE SOAKER





FASCIA COVER



NSW • ACT • VICTORIA

FASCIA COVER DURAKOTE® 25%

White, Brown, Heritage Red, Smooth Cream, Merino, Jasmin Brown, Slate Grey, Iron Grey, Mountain Blue, Dusk, Off White, Birch, Gull Grey, Armour Grey, Mist Green, Caulfield Green, Monolith, Ebony, Basal, Territory, Wallaroo, Gulf, Manteal, Coventry.

VALLEY DURAKOTE®

Slate Grey, Ebony, Monolith, Tuscan Red.

VALLEY PLAIN

STEEL FASCIA ANGLES MAY BE USED ON FASCIA COVER



90° & 45° INTERNAL ANGLES



EXTERNAL 90° ANGLE



INTERNAL STRAIGHT JOINER



EXTERNAL 45° ANGLE

DIMENSIONS FASCIA COVER

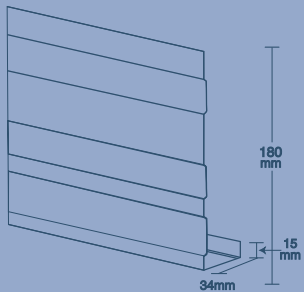

VALLEY

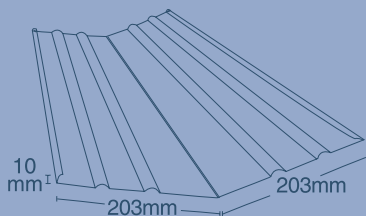

INTERNAL 90° ANGLE ON FASCIA COVER



FOLDED FASCIA COVER

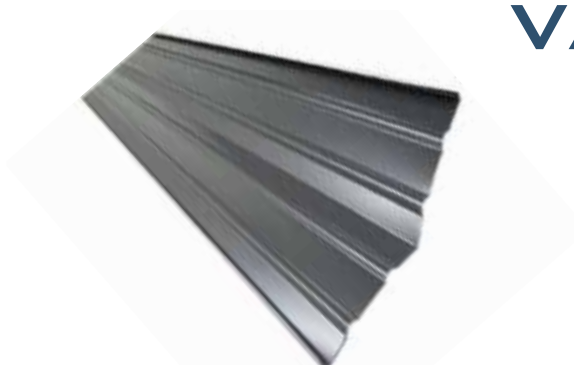

VALLEY



HALF ROUND

FLOW RATE:

Volume in 1m length with overflow holes

1.5 litres / second.

2.5 litres / second without overflow holes.

6.48 litres measured to overflow holes.

7.16 litres measured to back of gutter.



NSW • ACT • VICTORIA

HALF ROUND DURAKOTE® 80% GLOSS

Available Slotted or Unslotted.

Heritage Red, Smooth Cream, Merino, Jasmin Brown, Slate Grey, Iron Grey.

HALF ROUND DURAKOTE® 25% GLOSS

Available Slotted or Unslotted.

Heritage Red, Smooth Cream, Merino, Jasmin Brown, Slate Grey, Iron Grey, Mountain Blue, Dusk, Off White, Birch, Gull Grey, Armour Grey, Mist Green, Caulfield Green, Monolith, Ebony, Territory, Coventry, Gulf, Manteal, Basal, Wallaroo.

HALF ROUND PLAIN

Available Slotted & Unslotted

Custom Cut Only

		
EXTERNAL 90° ANGLE	INTERNAL 90° ANGLE	EXTERNAL 45° ANGLE
N.B: We recommend that plain angles be painted prior to installation		
		
INTERNAL 45° ANGLE	EXTERNAL BRACKET (COLOUR SCREWS SUPPLIED)	
		
ANGLE CUTTING TEMPLATE (SUPPLIED WITH ORDER)	STOP END	
		
100 x 50MM NOZZLE	100 x 75MM NOZZLE	
		
HALF ROUND OVERFLOW NOZZLE 90MM/100x50MM/100x75MM	90MM ROUND NOZZLE	
		
LEAFGUARD FOR HALF ROUND		
N.B Leafguard requires some degree of maintenance after installation.		

DIMENSIONS HALF ROUND GUTTER

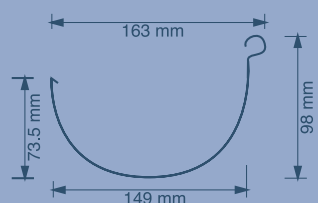



ROUNDLINE

FLOW RATE:

Volume in 1m length with overflow holes
 1.5 litres / second.
 2.5 litres / second without overflow holes.
 6.32 litres measured to overflow holes.
 7 litres measured to back of gutter.



NSW • ACT • VICTORIA

ROUNDLINE DURAKOTE® 80% GLOSS

Available Slotted or Unslotted.

Heritage Red, Smooth Cream, Merino, Jasmin Brown, Slate Grey, Iron Grey.

ROUNDLINE DURAKOTE® 25% GLOSS

Available Slotted or Unslotted.

Heritage Red, Smooth Cream, Merino, Jasmin Brown, Slate Grey, Iron Grey, Mountain Blue, Dusk, Off White, Birch, Gull Grey, Armour Grey, Mist Green, Caulfield Green, Monolith, Ebony, Territory, Coventry, Gulf, Manteal, Basal, Wallaroo.

ROUNDLINE PLAIN

Available Slotted & Unslotted

Custom Cut Only

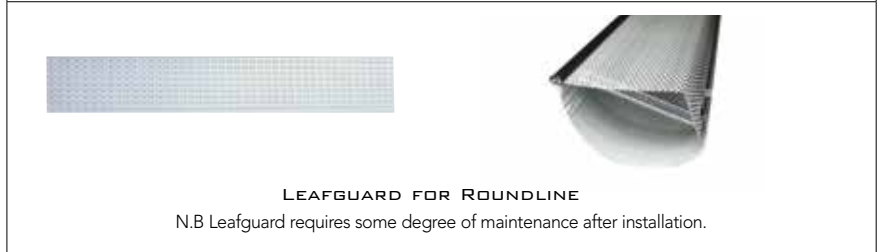
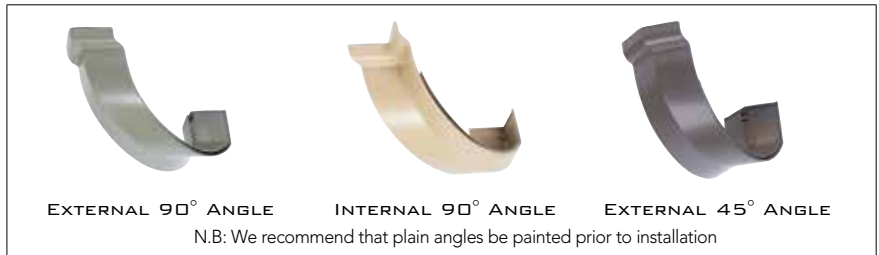

DIMENSIONS
ROUNDLINE GUTTER

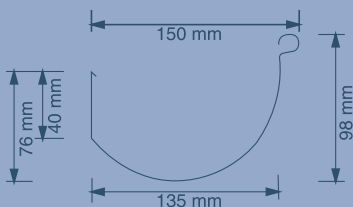



NU-LINE

FLOW RATE:

Volume in 1m length 5 litres / second.
12.6 litres measured to overflow holes.



NSW • ACT • VICTORIA

NU-LINE DURAKOTE® 80% GLOSS

White, Brown, Heritage Red, Smooth Cream,
Slate Grey, Iron Grey.

NU-LINE PLAIN

Slotted Only

<p>EXTERNAL 90° ANGLE</p>	<p>INTERNAL 90° ANGLE</p>
<p>N.B: We recommend that plain angles be painted prior to installation</p>	
<p>STRAIGHT JOINER</p>	<p>NO 1 EXTERNAL BRACKET</p>
<p>CONCEALED BRACKET</p>	<p>STOP END</p>
<p>BEAD & RAFTER BRACKET</p>	
<p>METAL ROOF BRACKET</p>	
<p>LEAFGUARD</p>	
<p>N.B Leafguard requires some degree of maintenance after installation.</p>	

DIMENSIONS

NU-LINE

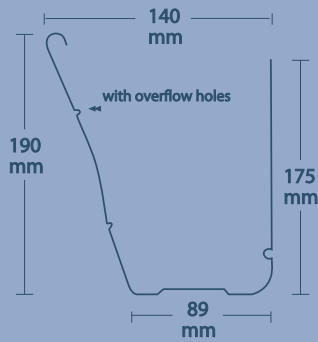

NU-LINE METAL ROOF

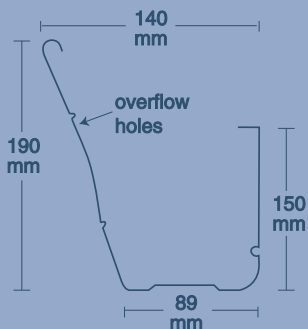



MINI-LINE

FLOW RATE:

Volume in 1m length 2.5 litres / second.
7.3 litres measured to overflow holes.



NSW • ACT • VICTORIA

MINI-LINE DURAKOTE® 80% GLOSS

White, Brown, Heritage Red, Smooth Cream, Merino, Jasmin Brown, Slate Grey, Iron Grey.

MINI-LINE DURAKOTE® 25% GLOSS

Ebony, Rivergum, Monolith

MINI-LINE PLAIN

Slotted Only

 <p>EXTERNAL 90° ANGLE</p>	 <p>INTERNAL 90° ANGLE</p>	 <p>EXTERNAL 45° ANGLE</p>
<p>N.B: We recommend that plain angles be painted prior to installation</p>		
 <p>INTERNAL 45° ANGLE</p>	 <p>EXTERNAL BRACKET (PAINTED)</p>	
 <p>OVERSTRAP BRACKET</p>	 <p>STOP END</p>	 <p>CONCEALED BRACKET</p>
 <p>METAL FASCIA SUSPENSION CLIP</p>	 <p>TIMBER SUSPENSION CLIP</p>	
 <p>MINI-LINE ERECTION BRACKET</p>		
 <p>LEAFGUARD N.B Leafguard requires some degree of maintenance after installation.</p>		

DIMENSIONS MINI-LINE

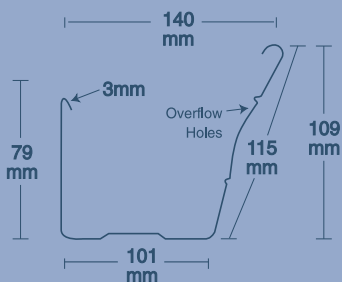



SQUARE-LINE

FLOW RATE:

Volume in 1m length 1.5 litres / second.
6.4 litres measured to overflow holes.

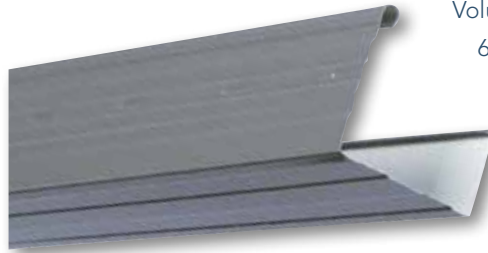

NSW • ACT • VICTORIA

SQUARE-LINE DURAKOTE® 80% GLOSS

White, Brown, Heritage Red, Smooth Cream, Merino, Jasmin Brown, Slate Grey, Iron Grey.

SQUARE-LINE DURAKOTE® 25% GLOSS

Dusk, Off White, Birch, Gull Grey, Armour Grey, Mist Green, Rivergum, Caulfield Green, Monolith, Ebony, Mountain Blue, Territory, Coventry, Gulf, Manteal, Basal, Wallaroo.

SQUARE-LINE PLAIN

Available Slotted Only

OLD STYLE QUAD DURAKOTE®

All Ace Colours. (NSW & ACT only)

Available in Classic & Exclusive Colours 80% only
Unslotted Only

OLD STYLE QUAD PLAIN (NSW & ACT only)

Available Unslotted Only



CONCEALED OVERSTRAP

STOP END

CONCEALED SUSPENSION BRACKET

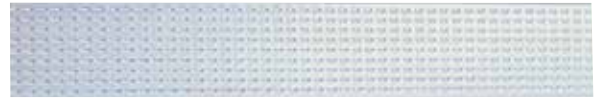

LEAFGUARD

N.B Leafguard requires some degree of maintenance after installation.

OLD STYLE QUAD

Only available in NSW & ACT.



DIMENSIONS SQUARE-LINE

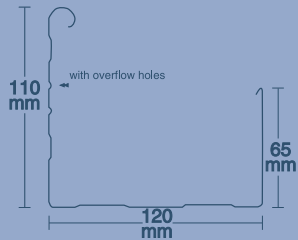

OLD STYLE QUAD GUTTER

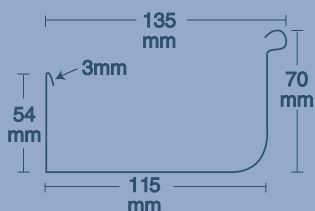

EXTERNAL 90° ANGLE

STOP END

N.B: We recommend that plain angles be painted prior to installation



INTERNAL 90° ANGLE

EXTERNAL BRACKET

CONCEALED BRACKET

N.B: Ace Quad Brackets can be used with Old Style Quad except for external brackets



ROLLFORM DOWNPIPE

100 x 50MM



FLOW RATE:

100 x 50mm
Volume in 1.8m length 9 litres.
Flow Capacity 3.5 litres per second.

NSW • ACT • VICTORIA

**100 x 50MM & 100 x 75MM ROLLFORM
DOWNPIPE DURAKOTE® 80% GLOSS**

Hunter Red, White, Federation Green, Brown, Heritage Red,
Smooth Cream, Merino, Jasmin Brown, Slate Grey, Iron Grey.

**100 x 50MM & 100 x 75MM ROLLFORM
DOWNPIPE DURAKOTE® 25% GLOSS**

Heritage Red, Smooth Cream, Merino, Jasmin Brown, Slate Grey,
Iron Grey, Mountain Blue, Dusk, Off White, Birch, Gull Grey,
Armour Grey, Mist Green, Rivergum, Caulfield Green, Monolith,
Ebony, Basal, Territory, Wallaroo, Gulf, Manteal, Coventry.

**100 x 50MM & 100 x 75MM ROLLFORM
DOWNPIPE PLAIN**

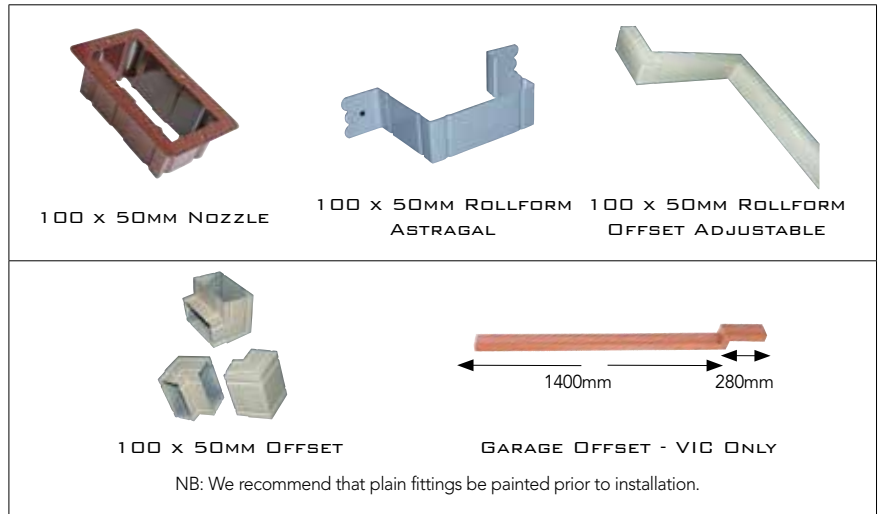

ROLLFORM DOWNPIPE

100 x 75MM



FLOW RATE:

100 x 75mm
Volume in 1.8m length 13.5 litres.
Flow Capacity 4.4 litres per second.

**DIMENSIONS
ROLLFORM OFFSET
ADJUSTABLE**

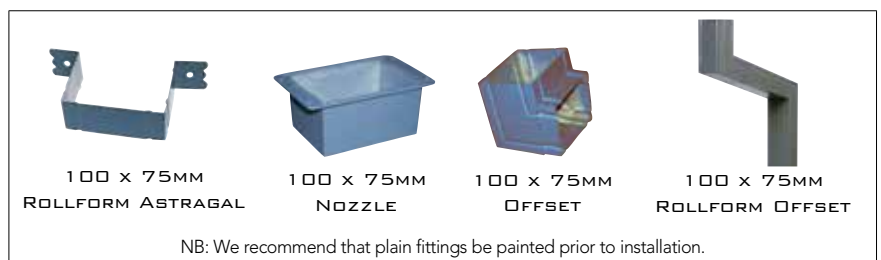
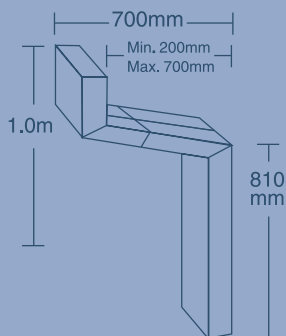



90MM ROUND DOWNPIPE



FLOW RATE:

90mm Round Downpipe
Volume in 1.8m length 11.44 litres.
Flow Capacity of 90mm 4.2 litres per second.

NSW • ACT • VICTORIA

90MM ROUND DOWNPIPE DURAKOTE® 80% GLOSS

Hunter Red, White, Federation Green, Brown, Heritage Red, Smooth Cream, Merino, Jasmin Brown, Slate Grey, Iron Grey.

90MM ROUND DURAKOTE® 25% GLOSS

Heritage Red, Smooth Cream, Merino, Jasmin Brown, Slate Grey, Iron Grey, Mountain Blue, Dusk, Off White, Birch, Gull Grey, Armour Grey, Mist Green, Caulfield Green, Monolith, Ebony, Basal Territory, Wallaroo, Gulf, Manteal, Coventry.

90MM ROUND DOWNPIPE PLAIN



90MM JOINER



ASTRAGAL



90MM NOZZLE



82° OFFSET

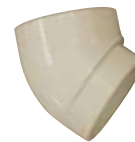

45° OFFSET



17° OFFSET

NB: We recommend that plain fittings be painted prior to installation.

RAINWATER HEADS & LEAFGUARDS

LEAFGUARD PAINTED 25% GLOSS & PLAIN

Slate Grey, Mountain Blue, Ebony.

ACE LEAF DIVERTER® & RAINWATER HEADS. All Ace Colours & Plain.

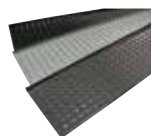

LEAFGUARD

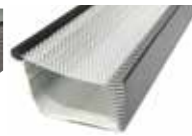

RAINWATER HEAD



RAINWATER HEAD



100 X 50MM
ACE LEAF DIVERTER®



90MM
ACE LEAF DIVERTER®



100 X 75MM
ACE LEAF DIVERTER®

NB: We recommend that accessories be painted prior to installation.

DIMENSIONS ACE LEAF DIVERTER®

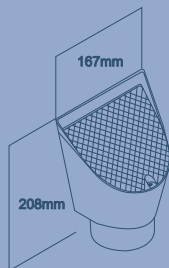

RAINWATER HEAD

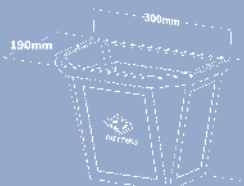
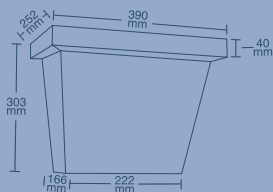

ACCESSORIES



25MM RAFTER
SCREW



SELF DRILLING
SCREW



NAIL HOLDER



40MM TWIST NAIL



NAIL PLUGS



1/8 POP RIVETS



200MM PHILIPS DRIVER BITS



150G TOUCH-UP PAINT
SPRAY CANS



SILICONE SEALER &
SILICON GUN



MEASURING TAPE



PRO SNIPS - LEFT, RIGHT
& STRAIGHT CUT



POP RIVET GUN



T-SOCKET SPANNER

NEW COMMERCIAL PRODUCTS AVAILABLE

- 200MM - 400MM HALF ROUND GUTTER
 - 100MM - 200MM SQUARE
- 100MM - 300MM ROUND DOWNPIPE

AVAILABLE IN
DURAKOTE, PLAIN ALUZINC, STAINLESS 304,
STAINLESS 316, COPPER AND COASTAL



LARGER HALF ROUND GUTTER



ROOF BATTENS

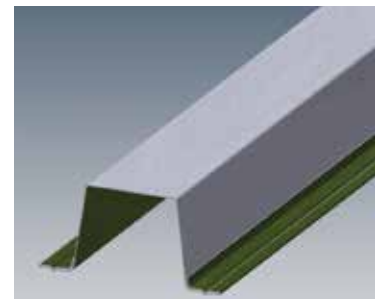
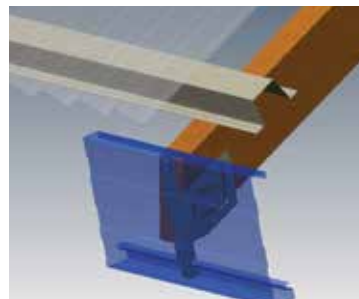

DIMENSIONS OF OUR PRODUCTS

NU-LINE

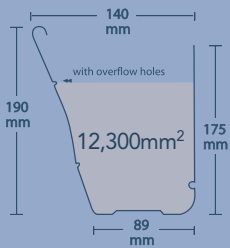

NU-LINE METAL ROOF

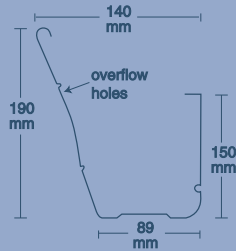

MINI-LINE

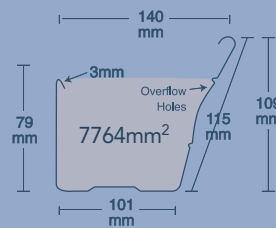

OLD STYLE QUAD

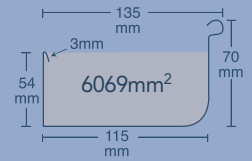

ROUNDLINE UNSLOTTED

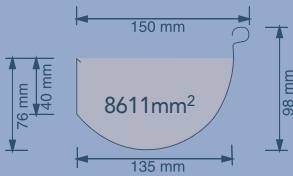

ROUNDLINE SLOTTED

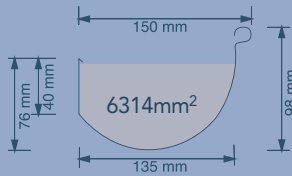

ACE QUAD

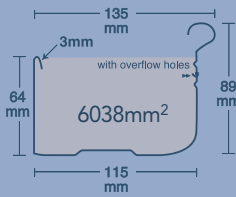

HALF ROUND UNSLOTTED

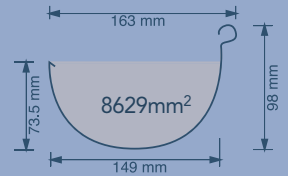

HALF ROUND SLOTTED

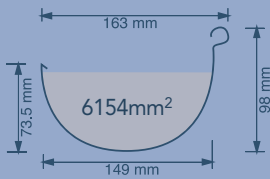

FASCIA COVER

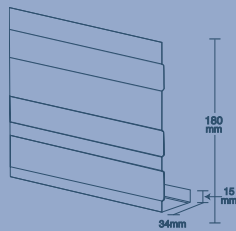

STEEL FASCIA

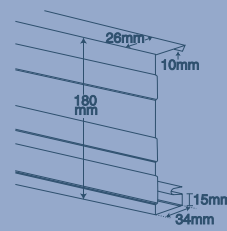

RAINWATER HEAD

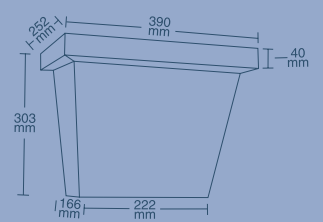

SQUARE-LINE

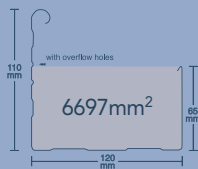

LEAF DIVERTER 90MM

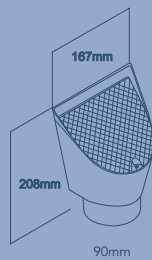

LEAF DIVERTER 100 X 50MM

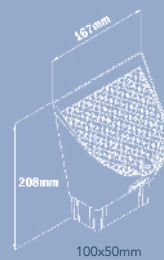

LEAF DIVERTER 100 X 75MM

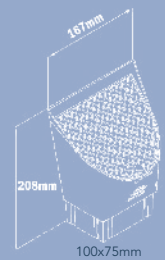

SMALL RAINWATER HEAD

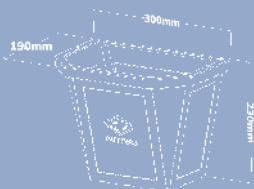

VALLEY

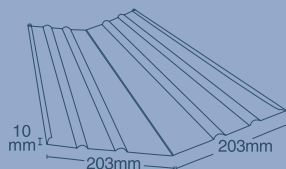

BARGE SOAKER

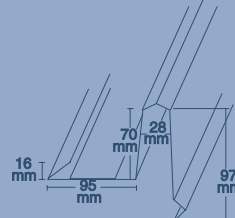



PREMIUM PRODUCTS

Severe Coastal and Industrial Environments can have corrosive effects on buildings. That's why Ace Gutters now manufactures Premium Products from **DURAKOTE®** Ultra-Coastal Steel for severe coastal and industrial environments. **DURAKOTE®** Ultra-Coastal is supported by a 15 year rainwater product warranty on Gutter & Fascia. Protect your home with materials that are aesthetically designed and built to last in corrosive environments.

ULTRA-COASTAL 100m - 200m from breaking surf.



SEVERE COASTAL

DURAKOTE® Ultra-Coastal Steel is recommended in areas which exhibit frequently the smell of salt or salt spray in the air. These conditions are found approximately within 100 to 200 metres from breaking surf.

ULTRA-COASTAL 100m - 200m from severe source of industrial emissions.



SEVERE INDUSTRIAL

DURAKOTE® Ultra-Coastal Steel is recommended in areas which exhibit frequently the smell of industrial chemicals. These areas are found approximately 100 to 200 metres from the source of severe industrial corrosive emissions.

DURAKOTE® ULTRA-COASTAL SUBSTRATE

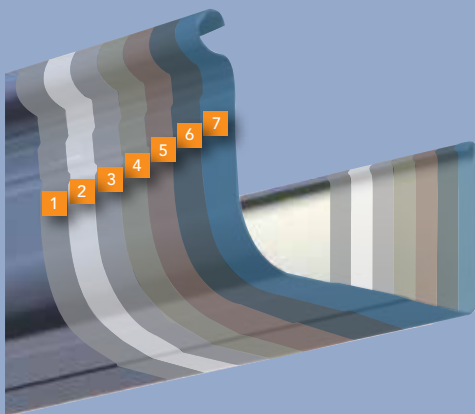

- 1 Backing Coat (Nominal 10µm)**
- 2** Corrosion Resistant Primer
- 3** Corrosion Resistant Coating
- 4 AluZinc (Aluminium Zinc Alloy Coated Steel AZ200)**
- 5** Corrosion Resistant Coating
- 6** Corrosion Resistant Primer (Nominal 5µm both sides)
- 7** Finish Coat (Nominal 20µm)



PREMIUM PRODUCTS

PRODUCT RANGE

Ace Gutters Premium Products are available in our three most popular gutter profiles Ace Quad, Half Round & Roundline. Steel Fascia also available.

PREMIUM ACCESSORIES

To compliment the premium product range Ace Gutters have produced a range of Premium Accessories. These accessories are made from zinc diecast which are conversion coated with chromate, chemically cleaned and then primed using Interpon MetaPrep™ Gold, a powder coating treatment designed as a barrier primer and surfacer for chemical and salt spray resistance. Powdered paint is applied as a top coat which is then oven baked onto the product resulting in a quality finish that ensures maximum durability in severe coastal and industrial environments.

PRODUCT AVAILABILITY CHART

PRODUCT	DURAKOTE® ULTRA-COASTAL STEEL
Ace Quad	
Half Round	
Roundline	
Steel Fascia	

PREMIUM PRODUCTS COLOUR CHART



SLATE GREY

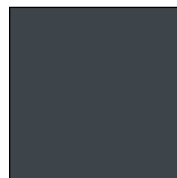

MONOLITH



WALLAROO

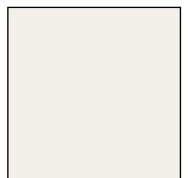

OFF WHITE

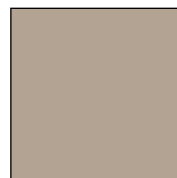

BIRCH

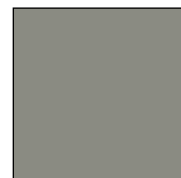

ARMOUR GREY

N.B These are approximate printed colours.

PREMIUM PRODUCTS

<p>QUAD</p> 	 <p>EXTERNAL 90° ANGLE</p>	 <p>INTERNAL 90° ANGLE</p>	 <p>EXTERNAL 45° ANGLE</p>	 <p>INTERNAL 45° ANGLE</p>	 <p>STOP END</p>
<p>HALF ROUND</p> 	 <p>EXTERNAL 90° ANGLE</p>	 <p>INTERNAL 90° ANGLE</p>	 <p>EXTERNAL 45° ANGLE</p>	 <p>INTERNAL 45° ANGLE</p>	 <p>STOP END</p>
<p>ROUNDLINE</p> 	 <p>EXTERNAL 90° ANGLE</p>	 <p>INTERNAL 90° ANGLE</p>	 <p>EXTERNAL 45° ANGLE</p>	 <p>INTERNAL 45° ANGLE</p>	 <p>STOP END</p>
<p>STEEL FASCIA</p> 	 <p>90° & 45° INTERNAL ANGLES</p>	 <p>EXTERNAL 45° ANGLE</p>	 <p>EXTERNAL 90° ANGLE</p>	 <p>BARGE MOULDS</p>	
<p>BRACKETS & CLIPS</p>					
 <p>HALF ROUND EXTERNAL BRACKET</p>	 <p>ROUNDLINE OVERSTRAP BRACKET PAINTED</p>	 <p>TIMBER SUSPENSION CLIP PAINTED</p>	 <p>METAL SUSPENSION CLIP PAINTED</p>	 <p>BARGE RAFTER BRACKET PAINTED</p>	

Ace Gutters have all the accessories available in Ace Quad, Half Round, Roundline, Steel Fascia.

DURAKOTE® Ultra-Coastal Gutter & Fascia are supported by a 15 year warranty.

ACE COLOUR RANGE

ACE EXCLUSIVE COLOURS

HIGH GLOSS



HUNTER RED

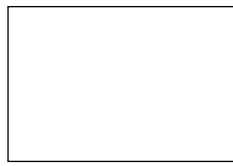

WHITE



FEDERATION GREEN

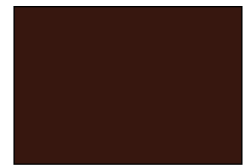

BROWN

LOW GLOSS



RIVERGUM

ACE CLASSIC COLOURS

HIGH GLOSS/LOW GLOSS



HERITAGE RED



SMOOTH CREAM



MERINO

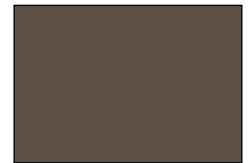

JASMIN BROWN

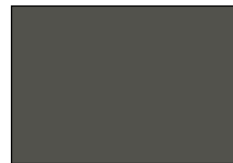

SLATE GREY

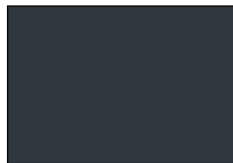

IRON GREY

ACE STYLISH COLOURS

LOW GLOSS ONLY



TERRITORY



COVENTRY



DUSK



OFF WHITE



BIRCH



GULL GREY



ARMOUR GREY

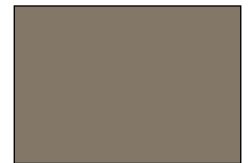

GULF



MANTEAL



MIST GREEN



CAULFIELD GREEN



MOUNTAIN BLUE



BASAL



WALLAROO



MONOLITH

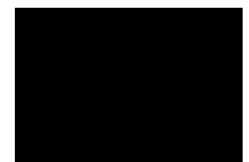

EBONY

N.B These are approximate printed colours. For accuracy, we recommend checking the chosen colour against an actual sample of the product before purchasing.

ACE PLUMBING SUPPLIES

TRADE & PUBLIC

We also have a self plumbing service store in NSW with a range of products to complete your bathroom, laundry and kitchen including stainless steel sinks, laundry tubs, basin and vanity units, Caroma toilet suites, Dux, Rheem and Rinnai Instantaneous Water heaters, fashion tapware, mixers, Euro Appliances - Ovens, Cook tops, Range hoods, Microwave and Dishwashers.

Ace Gutters is a valued Plumbtec Member aiming to be your one-stop bathroom, kitchen and plumbing supplies shop.



EXCEL[®] TAPWARE COLLECTION

WIDE RANGE AVAILABLE

Ace Gutters Plumbing Division has designed and produced its own quality decorative tapware and bathroom accessories – The EXCEL[®] Tapware Collection. This range of tapware and bathroom accessories will enhance any project from your domestic home package to architecturally designed commercial estates.



The EXCEL[®] Tapware Collection range includes EXCEL[®] Project Tapware, EXCEL[®] Classic MKII Mixers, EXCEL Plus[®] Lever Tapware, EXCEL Plus[®] Deluxe Tapware & Bathroom Accessories, EXCEL Executive[®] Tapware & Bathroom Accessories and EXCEL[®] Elite Tapware and Accessories.

A superior and quality endorsed product the EXCEL[®] Tapware Collection is manufactured to watermark licence # WMKA21061 and conforms to AS3718 performance & AS3662-AS/NZS 6400:2003 water saving.



OUR COMMITMENT TO CUSTOMER SERVICE



WE ARE FULLY COMMITTED TO MEETING THE NEEDS OF OUR CUSTOMERS BY PROVIDING QUALITY PRODUCTS, RELIABLE SERVICE AND VALUE FOR MONEY.

At Ace Gutters we value:

HONESTY AND INTEGRITY:

Being ethical in our relationship with customers, suppliers and staff.

MUTUAL RESPECT:

Building solid working relationships through trust, teamwork and faith in each other's ability.

ACCEPTANCE OF CHANGE:

The ability to adapt and evolve with the changing market place through product innovation, manufacturing techniques and technological advancements.

For over 60 years Ace Gutters has maintained a reputation as a manufacturer of the highest quality rainwater goods, offering complete systems of guttering and drainage. We are a Plumbtec member and have a large self-service site and a complete range of bathroom, kitchen and plumbing supplies. We have branches in Sydney and Melbourne and can supply to the Eastern States.



NSW

NSW

69 Boundary Rd
Mortdale NSW 2223
Phone: (02) 9584 4777
Gutter Fax: (02) 9584 4799
Email: sales@acegutters.com.au



VICTORIA

VICTORIA

12-14 Industrial Drive
Braeside VIC 3195
Phone: (03) 9586 4888
Gutter Fax: (03) 9586 4877
Email: acevic@acegutters.com.au



NOWRA

NOWRA

Lot 24 10 Cumberland Ave
South Nowra NSW 2541
Ph: 02 4428 7111
Fax: 02 4428 7199
Email: nowrasales@acegutters.com.au

Newcastle Area

Phone: (02) 4948 6611
(02) 4325 5200
Fax: (02) 4948 9543

Canberra Area

Phone: (02) 6140 4925

WEBSITE:

WWW.ACEGUTTERS.COM.AU

Disclaimer: While Ace Gutters has taken all reasonable care in preparing this brochure, Ace Gutters takes no responsibility for loss resulting from relying on its contents. Customers should make their own enquiries as to whether any products described in this brochure are suitable for their intended use.

Information in this brochure may change without notice.



EXCEL[®] Tapware Collection



The EXCEL[®] Tapware Collection has been uniquely designed to include a range that will enhance any project from your domestic home package to architecturally designed commercial estates.

contents

- 4. EXCEL *Executive*[®] Exclusive Tapware
- 6. EXCEL *Executive*[®] Bathroom Accessories
- 7. EXCEL *Plus*[®] Lever Tapware
- 8. EXCEL *Plus*[®] Deluxe Tapware
- 9. EXCEL *Plus*[®] Bathroom Accessories
- 11. EXCEL[®] MKII Mixers
- 13. EXCEL[®] Elite Mixers
- 15. EXCEL[®] Project Tapware



EXCEL *Executive*®

EXCLUSIVE TAPWARE

An architecturally designed range of impressive tapware constructed from solid brass with a dress ring to enhance the finishing touch of the product.

Suitable for the most modern home and commercial development.

EXCEL *Executive*® basin set
5 star 5 litres/min



EXCEL *Executive*® wall spa set
5 star 5.5 litres/min



EXCEL *Executive*® shower set
3 star 9 litres/min

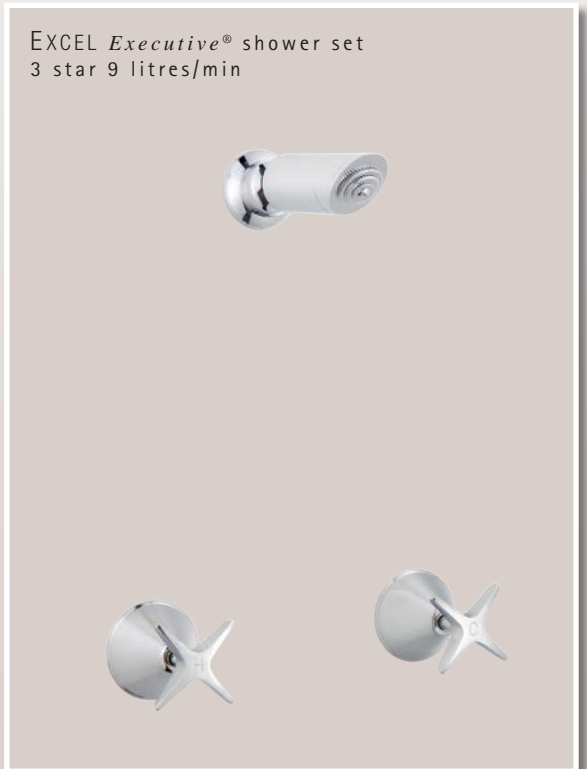

EXCEL *Executive*® hob spa set
5 star 5.5 litres/min



EXCEL *Executive*® bath set



EXCEL *Executive*® washing machine set



Available in the designer full chrome finish

Complies to Australian Government legislated WELS scheme



EXCEL *Executive*®
towel ring



EXCEL *Executive*®
toilet roll holder



EXCEL *Executive*®
soap dish



EXCEL *Executive*® tooth brush holder

EXCEL *Executive*®
robe hook



EXCEL *Executive*®

BATHROOM ACCESSORIES

Your bathroom will be enhanced with these stylish designed range of accessories. Made from solid brass to complement any contemporary bathroom.

**Finishes available in: CHROME
with a choice of chrome or gold trim**



EXCEL *Executive*® glass shelf

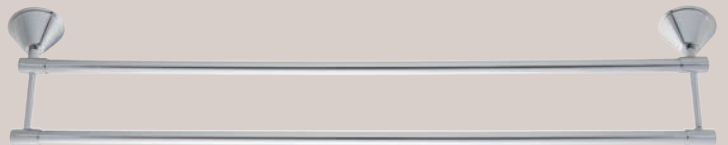

EXCEL *Executive*® double towel rail

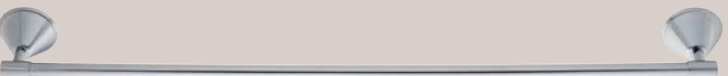

EXCEL *Executive*® single towel rail

EXCEL *Plus*®

LEVER TAPWARE

Effortless 1/4 Turn Action

Water Efficient Tapware

Solid Brass Construction

EXCEL *Plus*® Lever washing machine set C.P

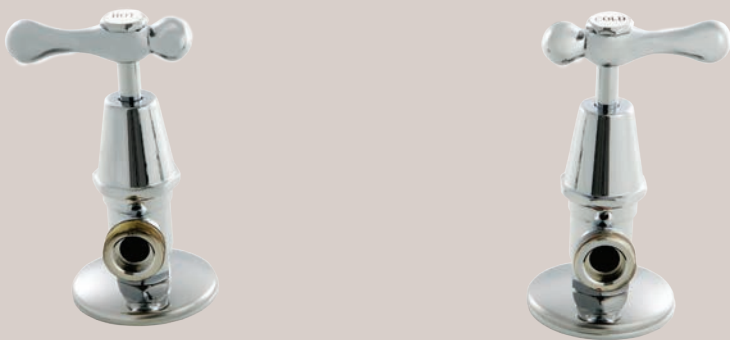

EXCEL *Plus*® Lever basin set C.P
5 star 5 litres/min



EXCEL *Plus*® Lever shower set C.P
3 star 9 litres/min



EXCEL *Plus*® Lever hob sink set C.P
3 star 9 litres/min



EXCEL *Plus*® Lever wall top assemblies



EXCEL *Plus*® Lever bath set C.P

EXCEL *Plus*®

DELUXE TAPWARE

A prestigious range of tapware made from solid brass combining smooth and effortless operation. Beautifully designed to enhance your bathroom, kitchen and laundry.



AVAILABLE IN THESE DESIGNER COLOURS:

- chrome
- white with chrome trim
- white with gold trim
- ivory with gold trim
- ivory with chrome trim
- chrome with gold trim

complete with double o-ring and metal flange adaptor

Complies to Australian Government legislated WELS scheme

EXCEL *Plus*®

BATHROOM ACCESSORIES

Complete your bathroom with a stunning range of accessories. Made from brass construction they will give your bathroom a lasting impression.

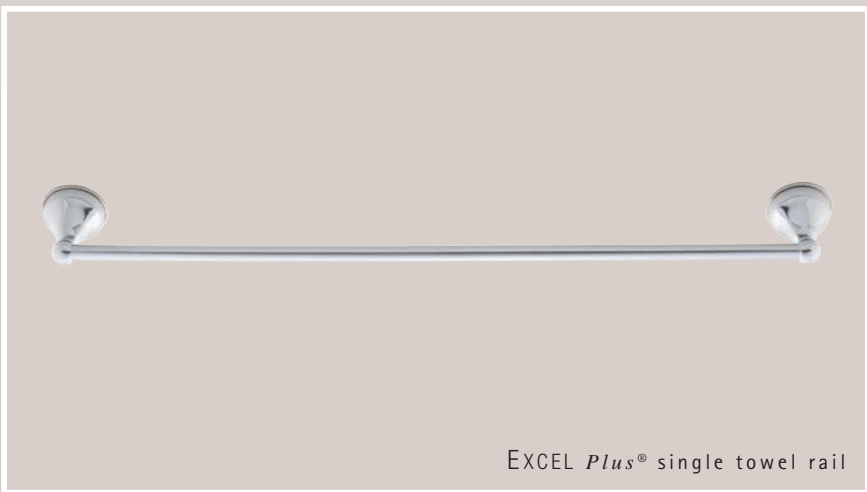
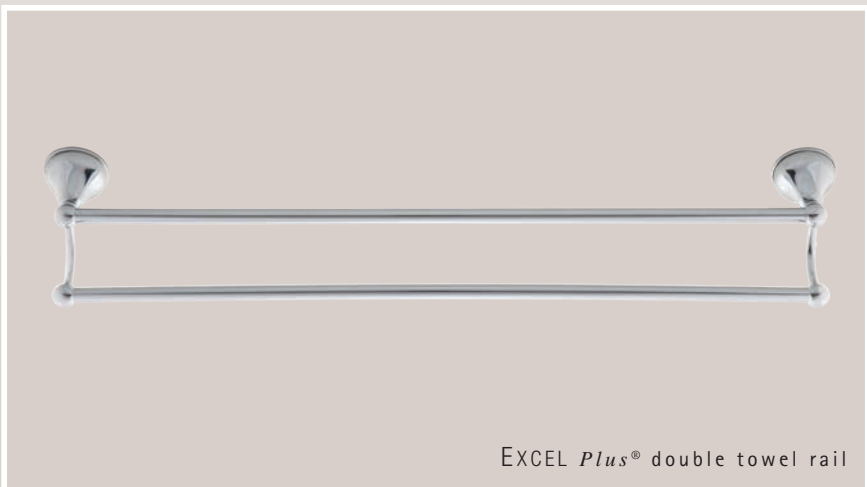



EXCEL®

MKII MIXERS

Water Efficient Tapware

5 year warranty on cartridge

Standardsmark license

Double fixing bolts

240mm centre to centre reach

150mm height from base to aerator

EXCEL® MKII



40mm deluxe shower mixer C.P

EXCEL® MKII

40mm deluxe sink mixer
4 star 7.5 litres/min



EXCEL® MKII



40mm deluxe
shower/divertor mixer C.P

EXCEL® MKII



40mm deluxe
swivel basin mixer
5 star 5.5 litres/min

EXCEL® MKII



40mm deluxe
cast body basin mixer
5 star 5.5 litres/min



EXCEL® *Elite*

EXCLUSIVE MIXERS

Water Efficient Tapware

Standardmark license

Watermark Accredited

5 Year Guarantee on cartridge

35mm Deluxe Cartridge

450mm Flexible Hose Connectors

EXCEL® ELITE



35mm deluxe bath/shower mixer C.P

EXCEL® ELITE



35mm deluxe gooseneck
sink mixer C.P.
5 Star 5.5 litres/min

EXCEL® ELITE



35mm deluxe bath/shower
mixer diverter C.P

EXCEL® ELITE



35mm deluxe
swivel basin mixer
6 star 4.5 litres/min

EXCEL® ELITE



35mm deluxe
bath wall mixer
w/180mm spout C.P.



EXCEL®

PROJECT TAPWARE

An elegant range of economical tapware made from solid brass. Stylish, yet affordable to suit any small to medium project.

AVAILABLE IN THREE FINISHES:

- chrome
 - white with chrome trim
 - chrome with gold trim
- complete with double o-ring

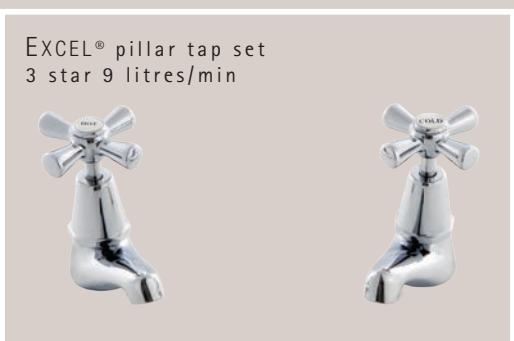
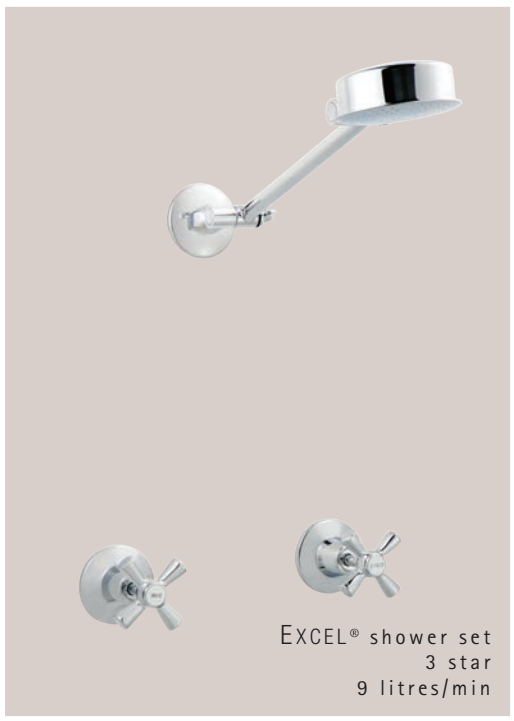

Complies to Australian Government legislated WELS scheme

EXCEL[®]

Tapware Collection



Australian
Standard
Lic No. 21061

Tested and approved
by Standardsmark
Licence for use
throughout Australia
& New Zealand.
AS/NZS 3718